

# TiNY8

# USER GUIDE

Discreet Control System 8+2 outputs / 3 inputs

P/N : P0050F0008

# TiNY8



Due to technological advances, the manufacturer reserves the right to modify the characteristics of this product without notice

# 1. TINY8 Safety and precautions

The safety of future users of this product depends on your installation. Therefore, it is critical that you read, understand, and follow all instructions contained in this installation guide.

**Some instructions and precautions that must be applied are listed below :**

- ✎ To install this equipment correctly, it is essential to have the understanding and the technical skills for the installation of automobile electronics.
- ✎ Never install any devices or accessories inside the airbag deployment area. Such installation might reduce the effectiveness of the airbag or prevent it from being deployed. It can also potentially damage or dislodge the device, causing serious or fatal injuries.
- ✎ If you need to drill a hole in the dashboard, make sure that both sides are completely free to avoid damaging the vehicle.
- ✎ Always install the console or the power module in a ventilated area, and never close to a heat source.
- ✎ It is imperative to dimension correctly all wires installed and connected to the positive battery terminal (see the chart on page 2) and protected by a proper fuse placed as close as possible to the battery.
- ✎ To ensure a correct operation of the device installed, it is necessary to make a perfect connection to the negative terminal. The negative output of the device must be connected to the negative terminal of the battery as directly as possible.
- ✎ The same applies to any elements controlled by the installed device.
- ✎ Make sure that none of the vehicle's original controls are affected by the installed device.
- ✎ Place this installation guide in a safe place and refer to it when necessary and for each installation.
- ✎ Failure to follow safety guidelines and instructions may cause material damages, injuries, or death to you and to others.

# 2. TINY8 Dimensioning of electric wires

It is essential and mandatory to dimension electrical wires correctly according to the currents used and the length of the wires. Failure to dimension correctly may cause fire inside the vehicle.

The Tiny-8 is equipped with protected static output.

One fuse of max 20A has to be mounted before the Tiny-8 as close as possible to the battery.

**ABACUS FOR THE DIMENSIONING OF ELECTRIC WIRES**

FILS		MAXIMUM AUTHORIZED CURRENT																	
mm <sup>2</sup>	AWG	5A	10A	15A	20A	25A	30A	35A	40A	45A									
0.34	22	1.8m	6 Feet	0.9m	3 Feet	X	X	X	X	X	X	X	X	X	X	X	X	X	X
0.5	20	2.9m	9.5 Feet	1.5m	5 Feet	0.9m	3 Feet	X	X	X	X	X	X	X	X	X	X	X	X
0.75	18	4.5m	15 Feet	2.2m	7.5 Feet	1.5m	5 Feet	1.2m	4 Feet	0.9m	3 Feet	X	X	X	X	X	X	X	X
1.5	16	7.5m	24.5 Feet	3.5m	12 Feet	2.4m	8 Feet	1.8m	6 Feet	1.5m	5 Feet	1.2m	4 Feet	1m	3.5 Feet	0.9m	3 Feet	X	X
2.5	14	12m	39 Feet	6m	19.5 Feet	4m	13 Feet	2.8m	9.5 Feet	2.5m	8 Feet	2m	6.5 Feet	1.6m	5.5 Feet	1.5m	5 Feet	1.3m	4.5 Feet
4	12	20m	62 Feet	9.5m	31 Feet	6m	20.5 Feet	4.7m	15.5 Feet	3.8m	12.5 Feet	3.2m	10.5 Feet	2.7m	9 Feet	2.3m	7.5 Feet	2.1m	7 Feet
6	10	30m	98 Feet	15m	49 Feet	10m	32.5 Feet	7.5m	24.5 Feet	6m	19.5 Feet	5m	16.5 Feet	4.2m	14 Feet	3.8m	12.5 Feet	3.3m	11 Feet
10	8	48m	156 Feet	24m	78 Feet	16m	52 Feet	11.8m	39 Feet	9.4m	31 Feet	8m	26 Feet	6.8m	22.5 Feet	5.9m	19.5 Feet	5.3m	17.5 Feet
16	6	75m	248 Feet	37m	124 Feet	25m	82.5 Feet	18.8m	62 Feet	15m	49.5 Feet	12.6m	41.5 Feet	10m	35.5 Feet	9.4m	31 Feet	8.3m	27.5 Feet
25	4	120m	395 Feet	60m	197 Feet	40m	131 Feet	30m	98.5 Feet	24m	79 Feet	20m	66 Feet	17m	56.5 Feet	15m	49.5 Feet	13.4m	44 Feet
35	2	190m	629 Feet	95m	314 Feet	63m	209 Feet	47m	157 Feet	38m	125 Feet	31m	104 Feet	27m	89.5 Feet	2.9m	78.5 Feet	21m	69.5 Feet

FILS		MAXIMUM AUTHORIZED CURRENT																	
mm <sup>2</sup>	AWG	50A	55A	60A	65A	70A	75A	80A	85A	90A									
0.34	22	X	X	X	X	X	X	X	X	X	X	X	X	X	X	X	X	X	X
0.5	20	X	X	X	X	X	X	X	X	X	X	X	X	X	X	X	X	X	X
0.75	18	X	X	X	X	X	X	X	X	X	X	X	X	X	X	X	X	X	X
1.5	16	X	X	X	X	X	X	X	X	X	X	X	X	X	X	X	X	X	X
2.5	14	1.2m	4 Feet	1m	3.5 Feet	0.9m	3 Feet	0.9m	3 Feet	0.9m	3 Feet	X	X	X	X	X	X	X	X
4	12	1.8m	6 Feet	1.7m	5.5 Feet	1.5m	5 Feet	1.5m	5 Feet	1.3m	4.5 Feet	1.2m	4 Feet	1.2m	4 Feet	1m	3.5 Feet	1m	3.5 Feet
6	10	3.0m	10 Feet	2.7m	9 Feet	2.4m	8 Feet	2.2m	7.5 Feet	2.1m	7 Feet	2m	6.5 Feet	1.8m	6 Feet	1.8m	6 Feet	1.6m	5.5 Feet
10	8	4.7m	15.5 Feet	4.2m	14 Feet	4m	13 Feet	3.6m	12 Feet	3.3m	11 Feet	3.2m	10.5 Feet	3m	10 Feet	2.7m	9 Feet	2.5m	8.5 Feet
16	6	7.6m	25 Feet	6.8m	22.5 Feet	6.2m	20.5 Feet	5.8m	19 Feet	5.3m	17.5 Feet	5m	16.5 Feet	4.7m	15.5 Feet	4.4m	14.5 Feet	4.2m	14 Feet
25	4	12m	39.5 Feet	11m	36 Feet	10m	33 Feet	9.2m	30.5 Feet	8.5m	28 Feet	8m	26.5 Feet	7.4m	24.5 Feet	7m	23 Feet	6.7m	22 Feet
35	2	19.2m	63 Feet	17.3m	57 Feet	16m	52.5 Feet	14.7m	48.5 Feet	13.7m	45 Feet	12.8m	42 Feet	11.8m	39 Feet	11.2m	37 Feet	10.6m	35 Feet

**X = Insufficient**

## 3. TINY8

## Product description

### 3.1. Description

**Tiny-8** is designed to control 8 positive outputs.

The system also have :

- 2 negative outputs;
- 1 "+ ignition contact" positive input;
- 1 negative input;
- 1 positive input.

A lot of functions are available and configurable through the console.

From the functions available :

- interlock function blue light/siren;
- interlock function blue light/grill light;
- marking functions linked or not to handbrake;
- siren status and/or blue light status management;
- 2 different types of directionnal lights management;
- push button functions;
- permanent output;
- several modes of automatic standby.

This list is not exhaustive, the last part of this user guide details all the available functions and how to configure them.

### 3.2. View of the assembly

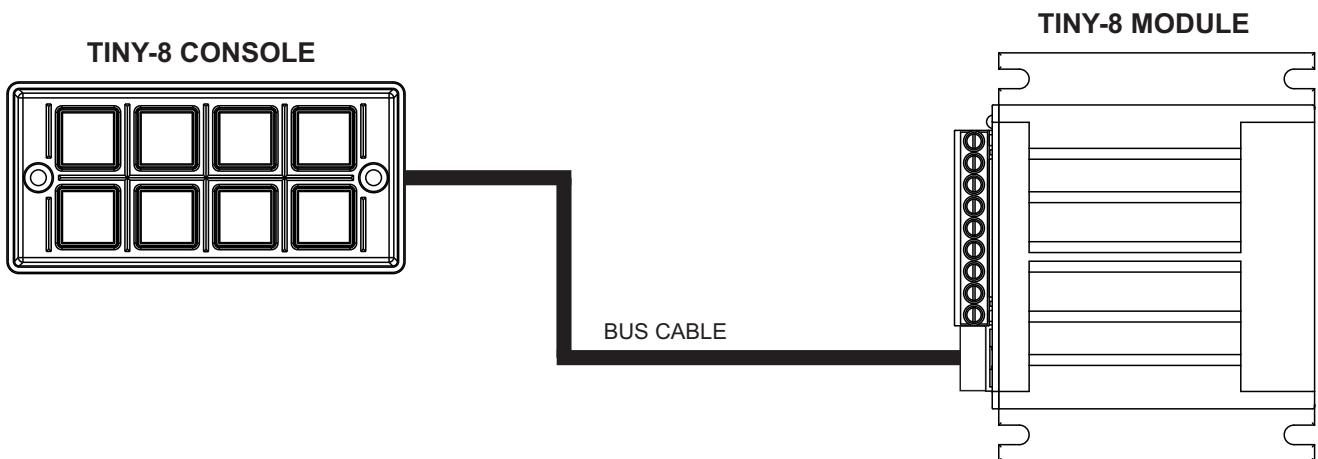

## 4. TINY8

## Elements identification

### 4.1. Console

Item	P/N	DESCRIPTION
1	P0040F0009	Tiny-8 Console
2	P0035F0016	Tiny-8 fixation kit

Qty  
1  
1

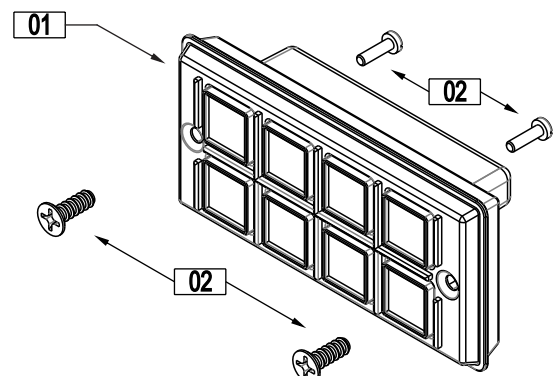

## 4. TINY8 Elements identification (continued)

### 4.2. Bus cable 2xRJ45 - Console < > Module

Standard length = 5 meters - P/N : P0020F0027/FTP

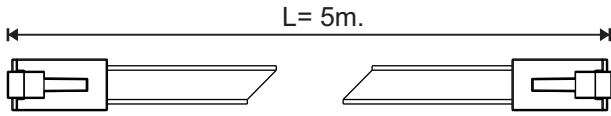

**Option on request :**

Length = 0.5 meter - P/N : P0020F0041

Length = 1 meter - P/N : P0020F0042

Length = 6 meters - P/N : P0020F0043

Length = 10 meters - P/N : P0020F0029/FTP



In order to ensure good communication between console and central unit, the length of the BUS cable cannot exceed 10m.



In order to ensure perfect operation, only BUS cables assembled and supplied by the manufacturer are accepted. Otherwise, unless authorised in writing, the manufacturer will not accept any warranty or liability on the equipment installed.



### 4.3. Power module

Item	P/N	DESCRIPTION
1	P0040F0066	Power Module TINY-8
2	P0020F0027	Cable 2xRJ45 L=5m.
3	A4600B0309	Connector 9 screw terminals

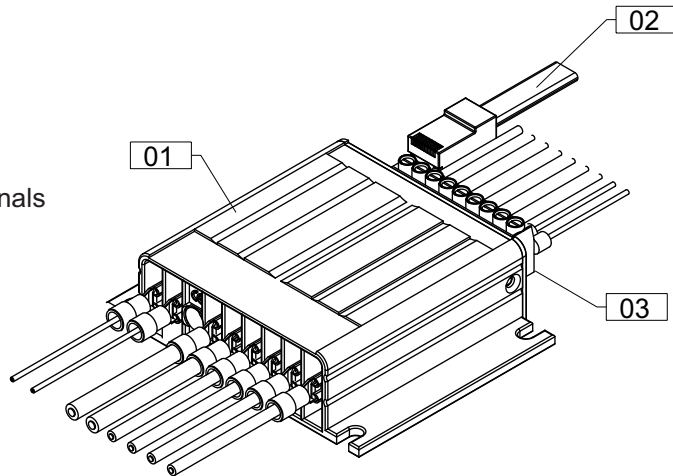

### 4.4. Pictogram collection

Item	P/N	DESCRIPTION	Qty
1	A6800B0025	80 pictograms set	1

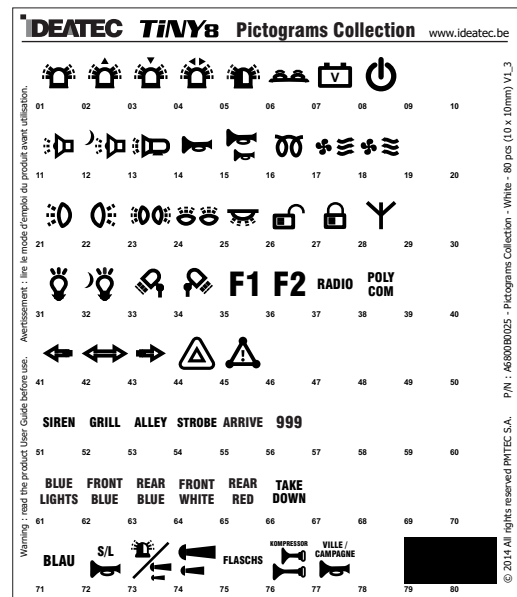

## 5. TINY8

## Console and module installation

The safety of future users of this product depends on your installation. Therefore, it is critical that you read, understand, and follow all instructions contained in this installation guide.



### 5.1. Console

#### 5.1.1. Front fixing

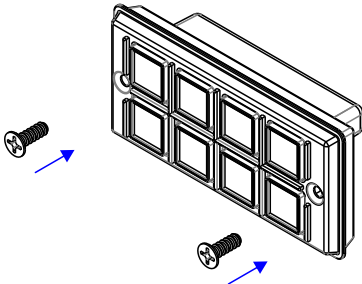

- Choose the best place to install the console in the vehicle.
- Locate and note the 2 fixation holes in front of the console.
- Place the console perfectly.
- Block the 2 head screws provided.

➤ **ATTENTION:** The force applied to tighten the screw depends on wall type. It must never be too high. The manufacturer will not provide repairs under warranty if the top side of the console is broken due to exceeded tightening force.

Drilling template on page 7



**Be sure before screw the console that the BUS cable is not in the way of the screw. The manufacturer cannot assure any warranty if cable is damaged by console fixing.**

#### 5.1.2. Rear fixing

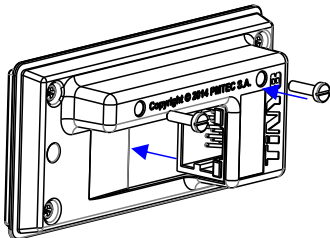

- Choose the best place to install the console in the vehicle.
- Locate and note the 2 fixation holes on the back side of the console.
- Place the console perfectly.
- Block the 2 head screws provided.

➤ **ATTENTION:** The force applied to tighten the screw depends on wall type. It must never be too high. The manufacturer will not provide repairs under warranty if the back side of the console is broken due to exceeded tightening force.

Drilling template on page 8

#### 5.1.3. Cable connection

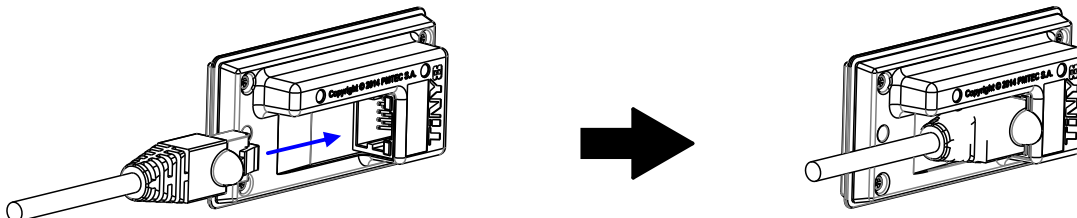

➤ If the place chosen to install the console allows it, the bus cable can be connected.



**Use only screws, nuts, and washers provided by the manufacturer. Using other, longer screws in the back of the console may seriously damage its internal parts. The manufacturer cannot assure any warranty or accept liability if other fixing elements or screw, nuts, and washers are used to install the console.**



## 5. TiNY8 Console and module installation (continued)

The safety of future users of this product depends on your installation. Therefore, it is critical that you read, understand, and follow all instructions contained in this installation guide.

### 5.1. Console (continued)

#### 5.1.4. Pictograms sticking

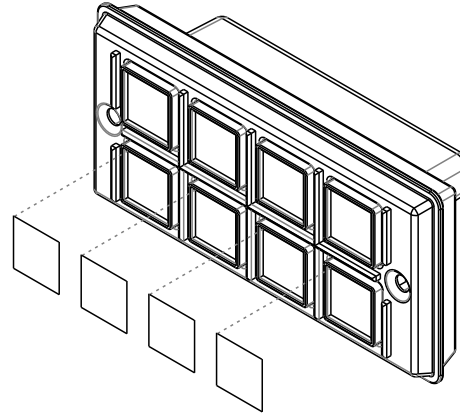
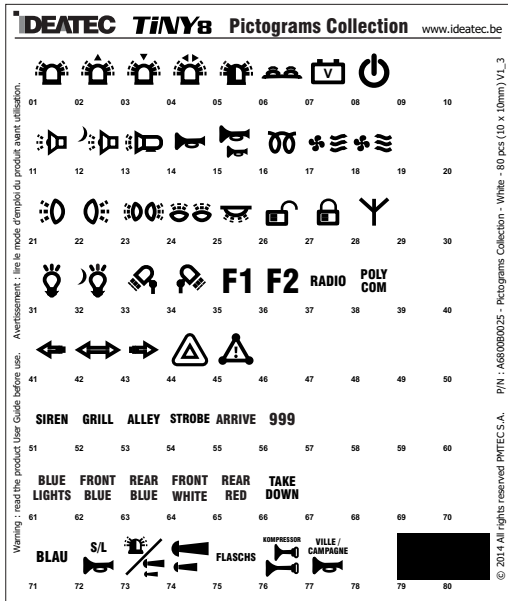

- ⇒ You can configure the keys on the keypad using the set of 80 pictograms provided.
- ⇒ To ensure good adherence of the pictogram to the cavity on each key, avoid touching the adhesive part of the pictograms and the key cavities with your fingers.

### 5.2. Power module

- ⇒ Choose a flat surface and use 4 appropriate fixation screws.
- ⇒ Always install the console or the power module in a ventilated area, and never close to a heat source.
- ⇒ Take into account the size of the different connectors that will be added to the assembly.



The power module must be protected against humidity.

Do not attempt to enlarge the mounting holes.

**i** Drilling template on page 8

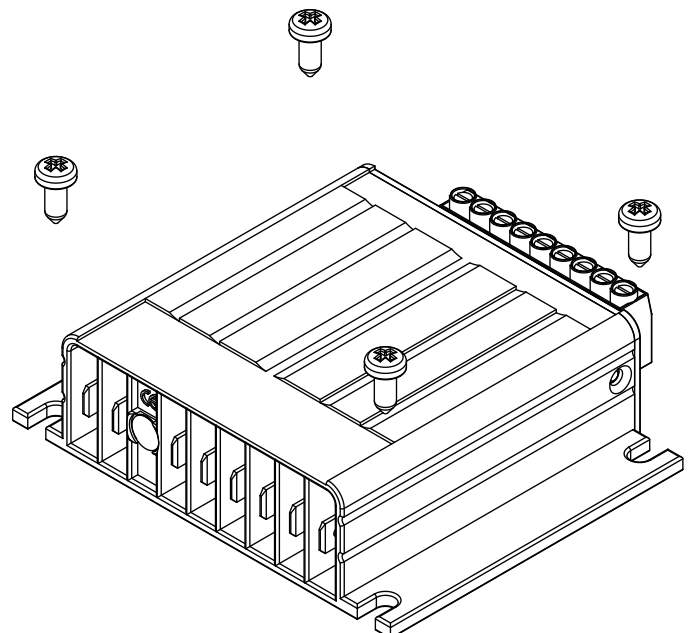

## 6. TINY8

## Drilling templates

### 6.1. Controlling the template scale after printing

**ATTENTION**



THE DRILLING TEMPLATES WERE CREATED BY THE EDITOR USING A 1:1 SCALE. FOR THIS REASON, SOME PRINTERS OR PRINTING SOFTWARE MAY CAUSE DISTORTIONS ON PRINTING. YOU SHOULD VERIFY THE SCALE BEFORE USING THE TEMPLATES BELOW.



The rulers below allow you to control the scale on the two axes :

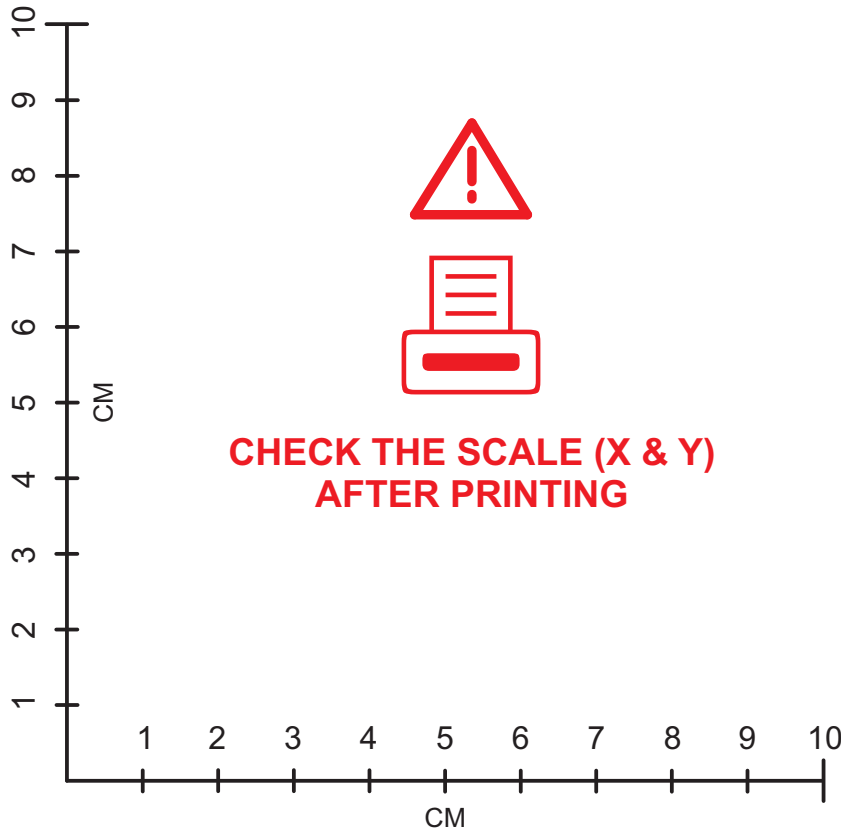

### 6.2. TINY-8 console

#### 6.2.1. Front view

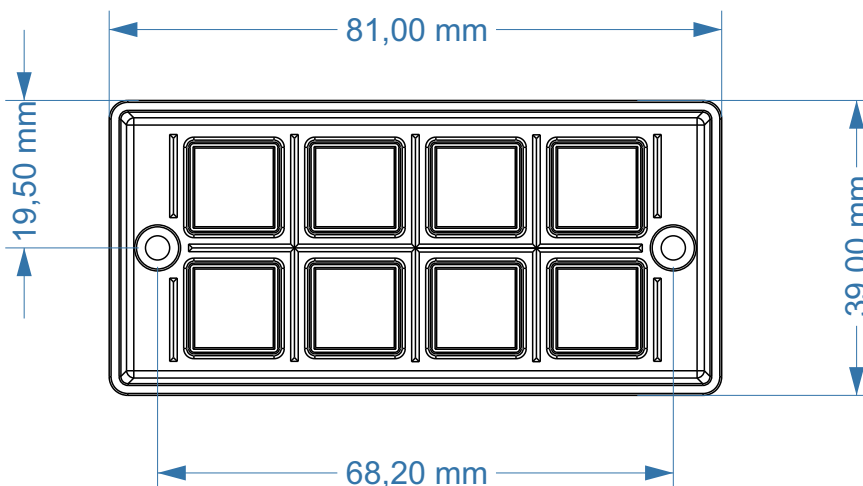

## 6. TINY8

## Drilling templates (continued)

### 6.2. TINY-8 console (continued)

#### 6.2.2. Rear view

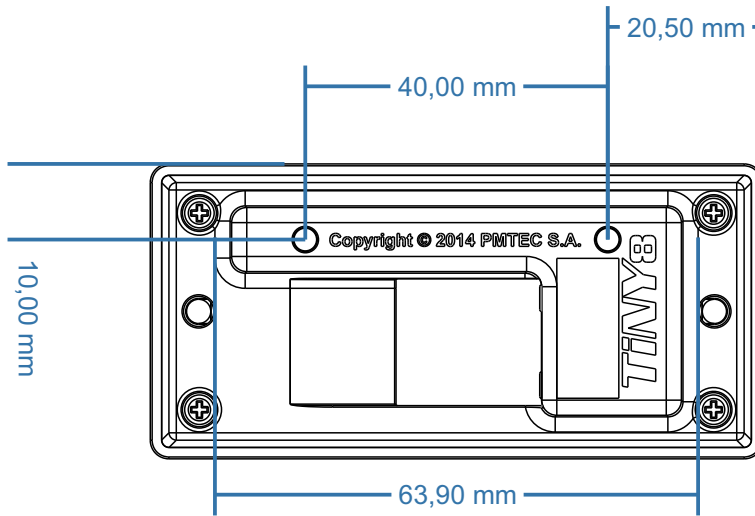

**CHECK THE SCALE (X & Y)  
AFTER PRINTING**

### 6.3. TINY-8 power module

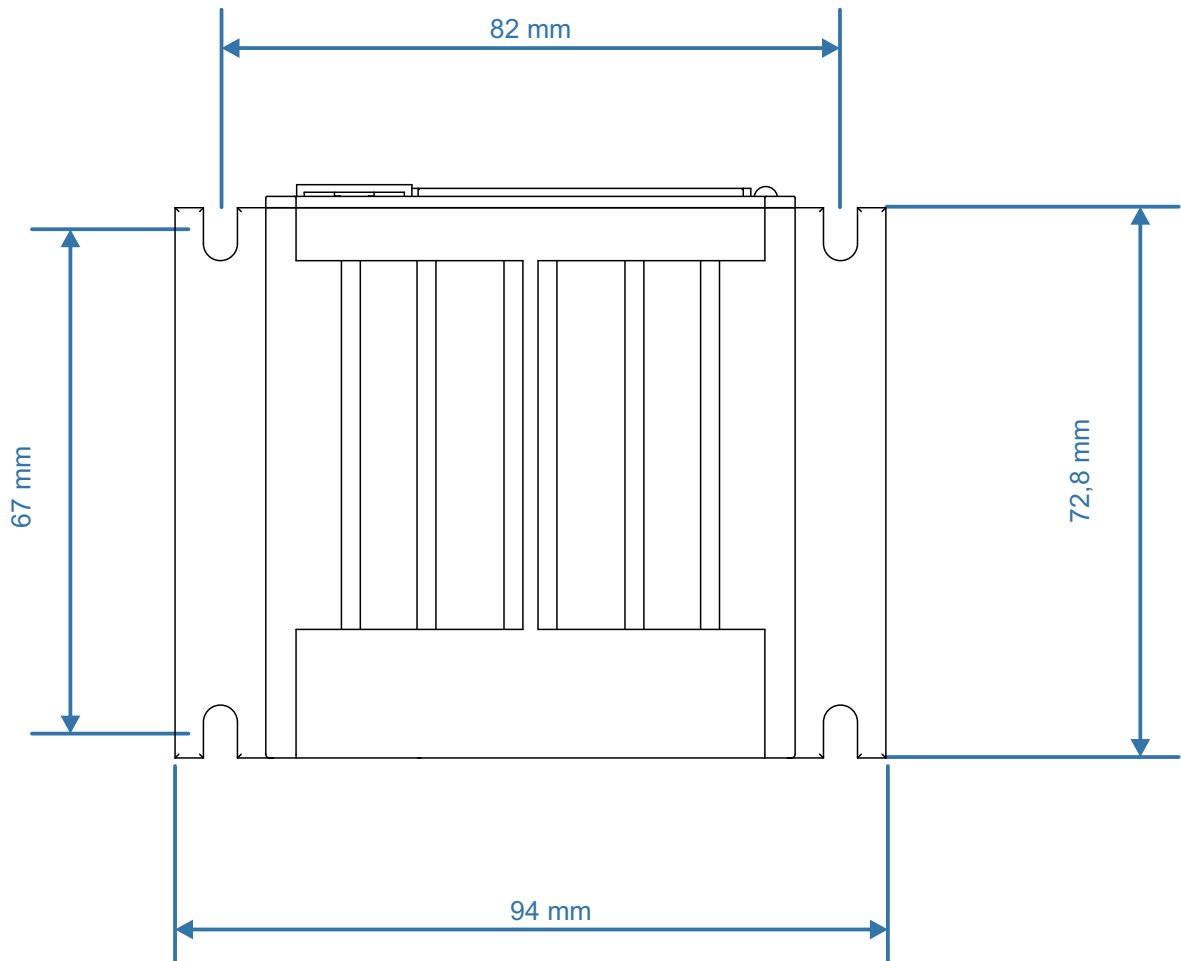



## 7. TiNY8

## Technical characteristics

### 7.1. Console

Operating Voltage	: +5VDC ±5% supplied by the module
Operating Temperature	: from -25°C to +60°C
Connection Type	: RJ45 (non-crossed)
Weight	: 33 gr.
Dimensions (L x W x D)	: 81 x 39 x 24 mm

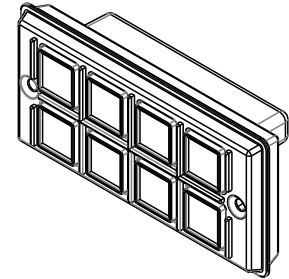

Automatic Backlighting

### 7.2. Power module

Operating Voltage	: from +10 to +28.5VDC
Operating Temperature	: from -25°C to +60°C
Number of positive outputs	: 8
Number of negative outputs	: 2
Number of positive inputs	: 2
Number of negative inputs	: 1
Maximum current. /positive output	: 10A
Maxi. current /negative output	: 2A
Maxi. current general	: 20A
Type of output	: Static auto-protected
Power module weight	: 80 gr
Dimensions over all	: 94 x 73 x 26 mm

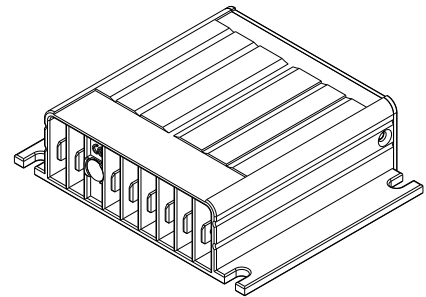

## 8. TiNY8

## Wiring diagram

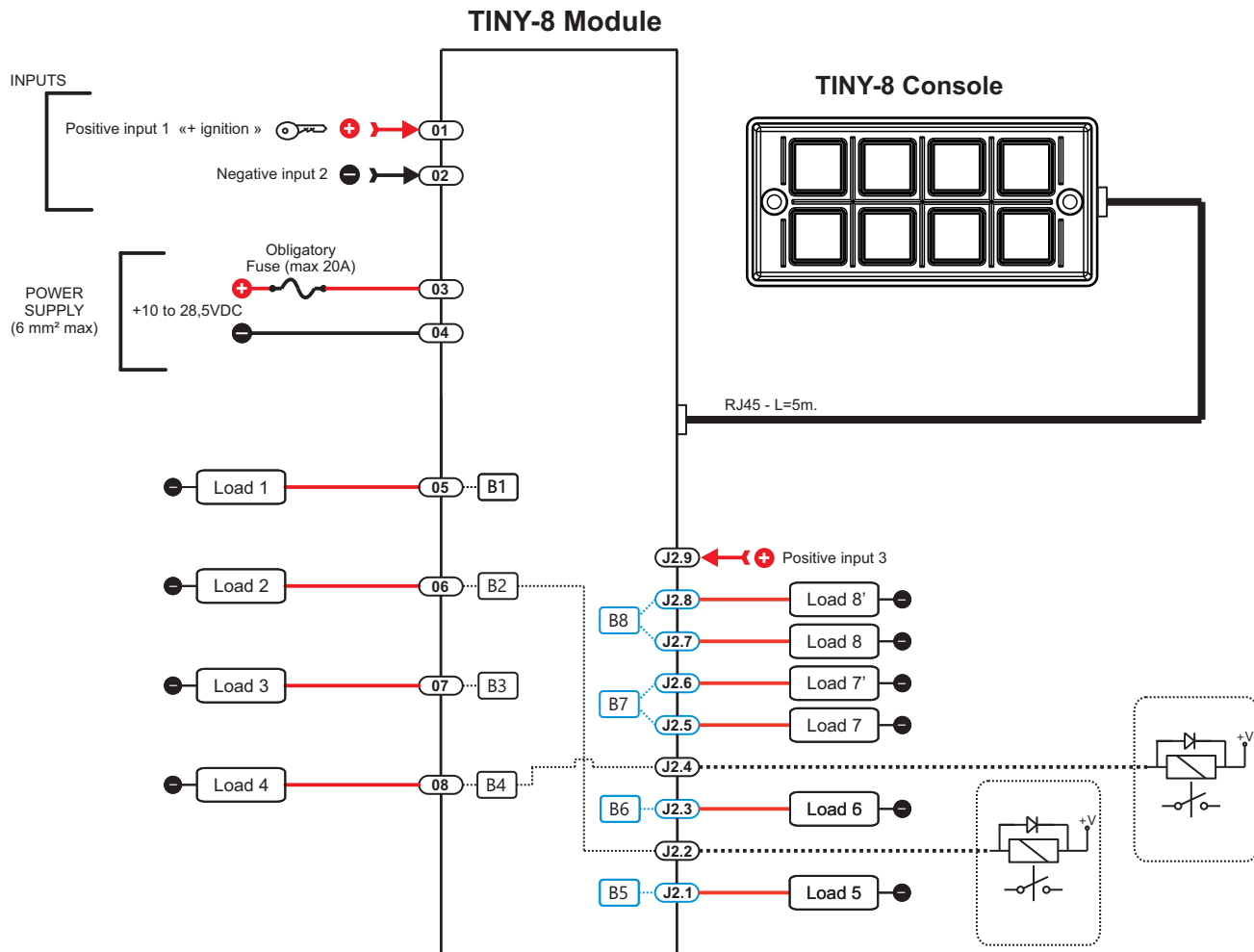

## 9. TINY8

## Connecting

### 9.1. Connectors and wire terminals supplied

To ensure correct and reliable connections, it is imperative to crimp an adequate terminal on each wire.

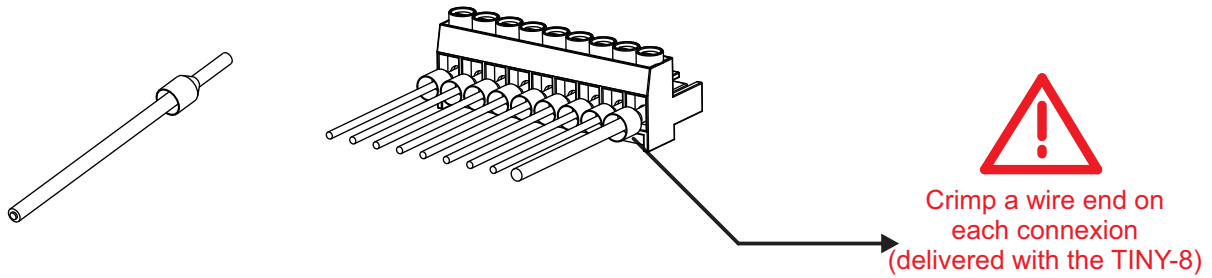

### 9.2. TINY-8 power module wiring

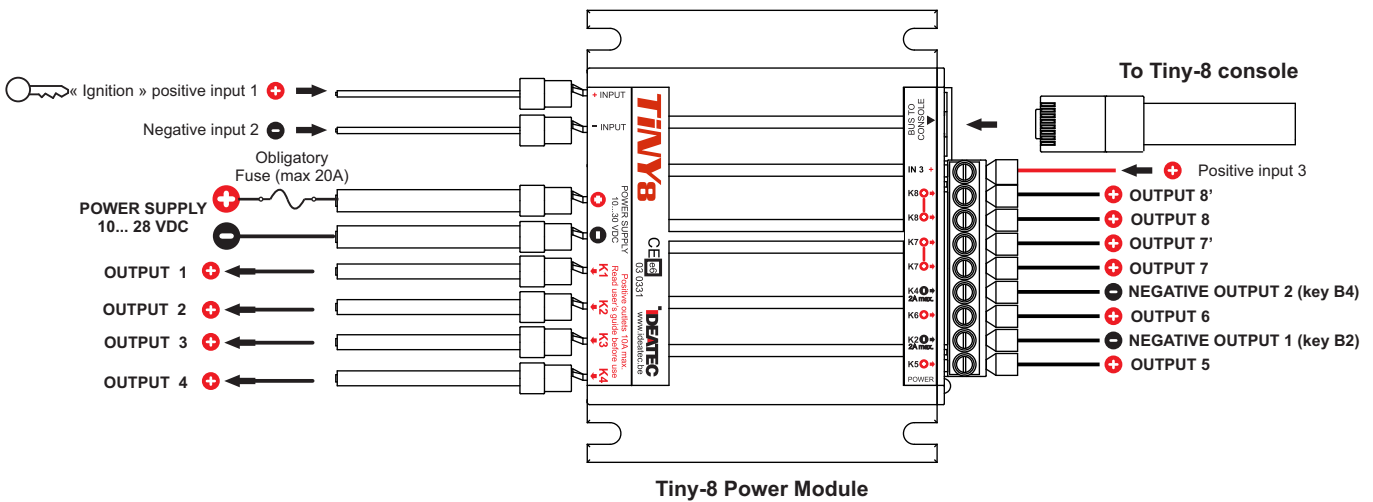

Each positive output can deliver up to 10A. The positive outputs 1, 2, 3 and 4 with the terminal type Faston is better for high current near 10A.  
 The total current is maximum 20A and the input must be protected by fuse.  
 The negative outputs are limited to 2A.

## 10. TINY8

## Configuration by default

The 8 keys on the console have predefined functions. However, it is possible to assign automatic functions to each of them.

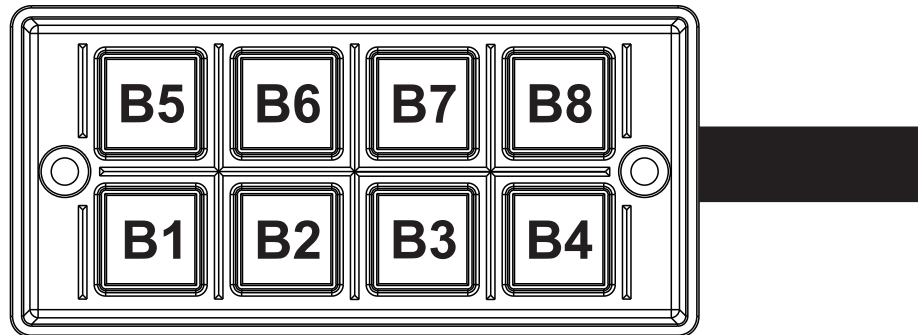

### B1 – POSITIVE OUTPUT 1

Master function (the blue lights for example).

### B2 – POSITIVE OUTPUT 2 & NEGATIVE OUTPUT 1

Slave function. If user pushes on the key B2 then the key B1 is activated too.

Automatically disabled when handbrake is activated and not activated again when handbrake is released.

Siren can be activated by positive input 3 (switch mode), when input 3 signal disappears then siren is going OFF too.

### B3 – POSITIVE OUTPUT 3

Function for B3 linked to key B1. If user pushes on the key B1 then the key B3 is activated too.

Automatically disabled when handbrake is activated and not activated again when handbrake is released..

### B4 – POSITIVE OUTPUT 4 & NEGATIVE OUTPUT 2 - POWER OFF & ON (LONG PRESS)

### B5 – POSITIVE OUTPUT 5

### B6 – POSITIVE OUTPUT 6

### B7 – POSITIVE OUTPUT 7

### B8 – POSITIVE OUTPUT 8

### TINY-8 EXAMPLE

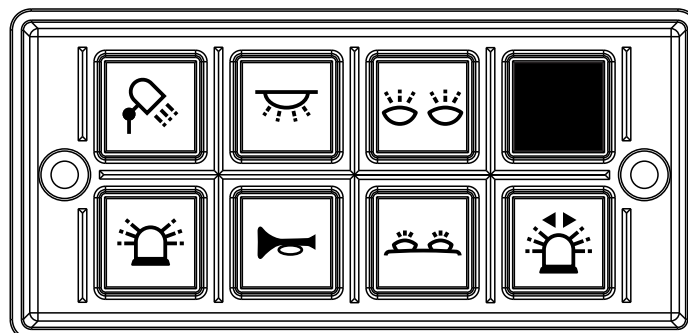

The automatic sleep mode is by default active after 1 minute if no keys are active and the positive signal after contact missing on positive input 1. Then after 1 minute the console and the permanent positive outputs will be shut off too.



The options by default explained after page 15 are written in blue color.

# 11. TiNY8 Operation & Configuration

## 11.1. TINY-8 console

The console TINY-8 with 8 keys allows a pictogram to be inserted (Fig. 1). A set of 88 pictograms is provided (Fig. 2).

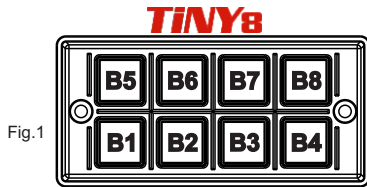
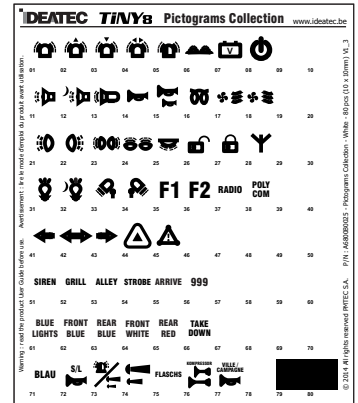

Fig.1

Fig.2



To make sure that the pictogram adheres properly in the cavity of each key, you should avoid touching the adhesive part of the pictograms and the cavity of the keys.

## 11.2. Description of the different light

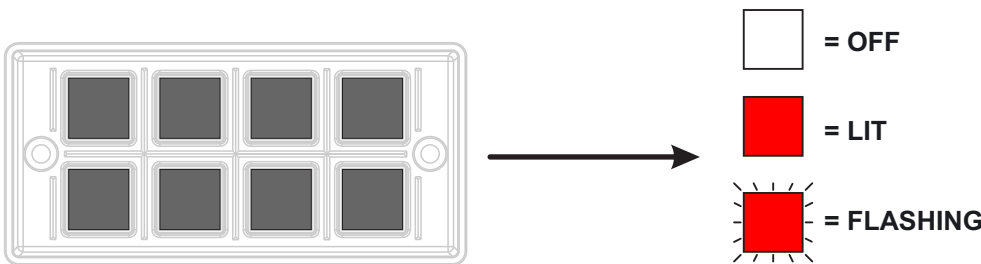

## 11.3. Keys operation

### 11.3.1. No backlighting is present and key B4 is lit briefly every 5 seconds.

This state indicates that the Tiny-8 is in "sleeping" mode. In this state, the power consumption of the system is reduced to a minimum and all outputs are inactive. There are two ways of "waking up" the system. Press the key B4 on the console or to apply a signal to the positive input 1 ("Ignition Key Signal"). With either solution, at that time, the console will sound a very brief alarm and the console backlighting will be activated. Key B4 will stop sending its brief light signal. If some outputs are configured in "permanent" mode (no function on the linked key) then they are automatically activated.

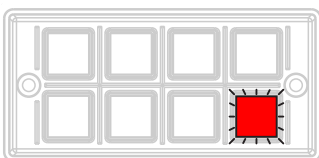

The console backlighting is only visible in the dark or semi-darkness.

### 11.3.2. The key B1, B2, B3, ... or B4 is permanently lit.

This state indicates that the function associated with that key is activated therefore simply press the key again to turn it off and deactivate the associated function.

Example :

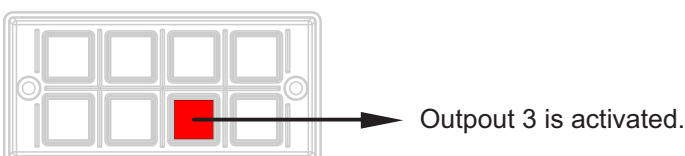

# 11. TiNY8 Operation & Configuration (continued)

## 11.4. Before to configure the Tiny-8

**i** In order to make the configuration easier, it is recommended that you choose and place all pictograms on the console correctly. Additionally, touching the keys without placing the pictograms first may prevent proper adherence.

### 11.4.1. Selection and placement of pictograms on the keys

A collection of more than 80 pictograms is provided with the console. Select the symbols that match your application and place them on each cavity. Never touch the adhesive part with your fingers. If one or more keys will not be used, it is recommended that you place black adhesives provided for this purpose.

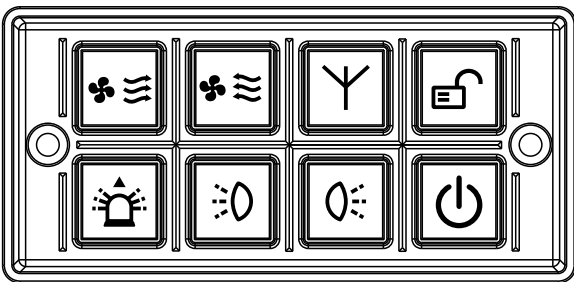

Example 1

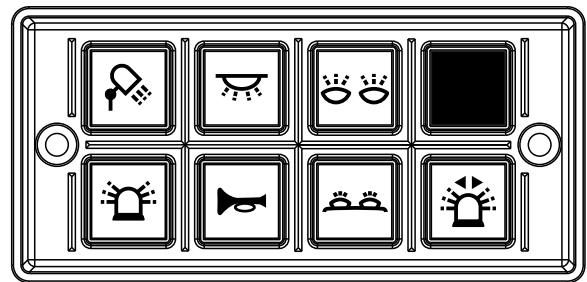

Example 2

### 11.4.2. Conditions for configuration.

The console must be connected correctly to the power module using only the RJ45 provided from the manufacturer (see page 4). The power module must be powered by 10 to 28,5VDC.

Once the assembly is powered, the console sounds two brief warnings and its backlight is activated. From this moment, the configuration mode is accessible for five minutes, after which you will not be able to access it. If, after this time, you need to access the configuration again, disconnect the power module from the power supply for  $\pm 3$  seconds, and reconnect it. For this, it is always recommended to remove the positive wire from the power supply and to leave the negative one.

### 11.4.3. To enter in configuration mode.

There are two configuration modes for Tiny-8. Mode 1 allows you to configure the keys 1 to keys 8 and inputs. Mode 2 allows you to configure conditions and simulation for arrow stick functions and standby modes. Connect power module on power supply and keep keys B1 and B3 for mode 1 pressed (Fig.1) or keys B2 and B4 pressed for mode 2 (Fig.2) during 5 seconds then release them. You are in configuration mode then you have the possibility to change the property of each key of the console.

**CONFIGURATION MODE 1**

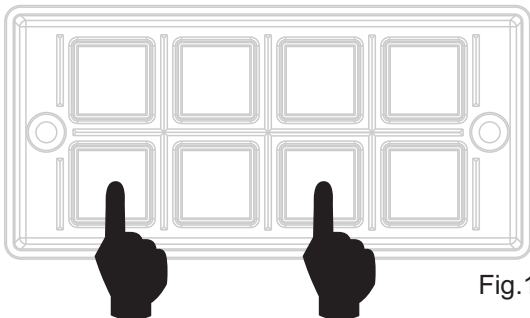

Fig.1

**CONFIGURATION MODE 2**

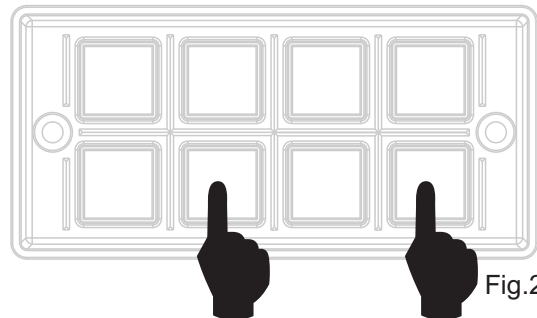

Fig.2



**ATTENTION**  
FOR REASONS OF SAFETY, THE CONFIGURATION IS ONLY ACCESSIBLE WITHIN THE FIRST FIVE MINUTES. IF NO ACTION IS TAKEN DURING ONE MINUTE, THE SYSTEM EXITS CONFIGURATION AUTOMATICALLY. HOWEVER, ANY CHANGES MADE ARE SAVED.

## 11. TiNY8

## Operation & Configuration (continued)

### 11.4. Before to configure the Tiny-8 (continued)

#### 11.4.3. To enter in configuration mode (continued)

When you enter into configuration mode, each key is flashing several times cyclically. The number of flashes is corresponding to the selected option.

Example for the configuration by default :

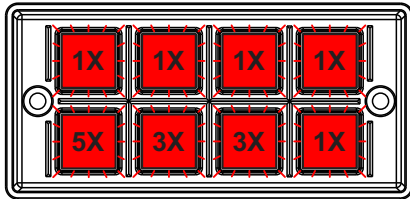

If you wish to select the option 6 in place of option 5 for key 1, you have to make a short press ↻ 👆 on B1.

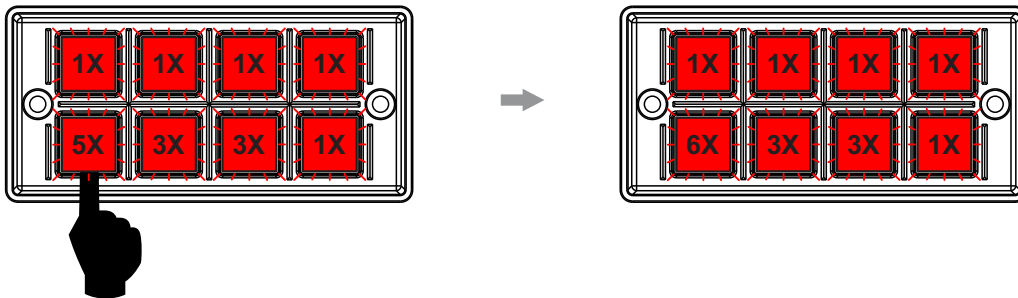

#### 11.4.4. To save your configuration

When you finish your selection, save your configuration by pressing B1 & B3 if you were in the mode 1, B2 & B4 if you were in mode 2 once again during 3 seconds.

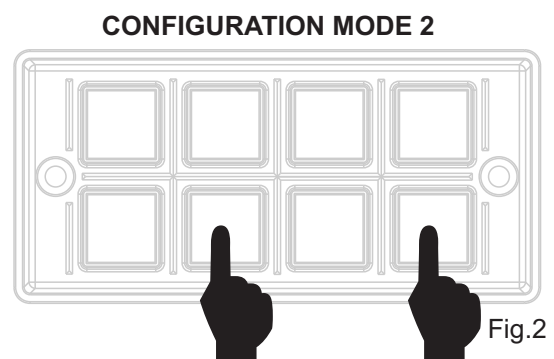
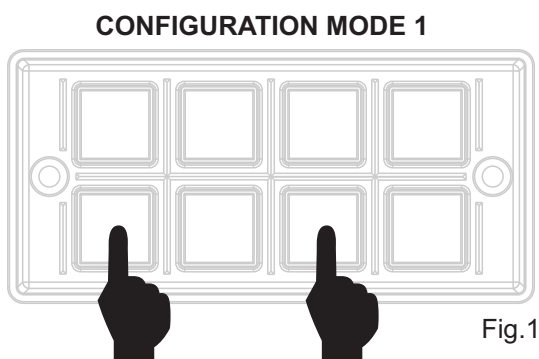

# 11. TiNY8 Operation & Configuration (continued)

## 11.5. Tiny-8 Configuration - MODE 1

### 10.5.1. Key B1 and positive input 3 configuration



By default the key B1 is a switch and controls the positive output 1. The positive input 3 is an external activator for the siren in « switch » mode. It's possible to disable the key B1 and to put a black pictogram on the key to notify the user of the console that the key is not available.





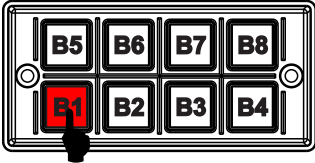











When the key is not available then the positive output 1 is a permanent positive output.

Key B1 is by default the Master key for all the functions linked in the B2, B2 or B4 configurations.

The positive input 3 functions are also configured by B1 key in configuration mode 1.



  = one pulse on the key

SELECTION	FLASHES	DESCRIPTION
  	0	Key B1 is not available and the positive output 1 is a permanent positive output. Positive input 3 is not used.
  	1	Key B1 is a switch and activates the positive output 1. Key B1 is the Master key by default. Positive input 3 is not used.
  	2	Key B1 is a momentary push button and activates the positive output 1 when it is pressed and positive output 1 is OFF when key B1 is released. Positive input 3 is not used.
  	3	Key B1 is available and activates the positive output 1. Key B1 is the Master key by default. <b>Positive input 3</b> is an input for <b>blue light status</b> . <b>Blue light (B1) is going OFF</b> after 4 seconds if no signal is connected to the positive input 3. 
  	4	Key B1 is available and activates the positive output 1. Key B1 is the Master key by default. <b>Positive input 3</b> is an input for <b>blue light status</b> if key B2 is configured as siren mode. <b>The siren (B2) is going OFF</b> after 4 seconds if no signal is connected to the positive input 3. 

# 11. TiNY8 Operation & Configuration (continued)

## 11.5. Tiny-8 Configuration - MODE 1 (continued)



### 10.5.1. Key B1 and positive input 3 configuration (continued)

SELECTION	FLASHES	DESCRIPTION
		<p><b>5</b></p> <p>Key B1 is a switch and activates the positive output 1. Key B1 is the Master key by default. <b>Positive input 3</b> is a external activator in <b>switch mode</b> if the key B2 is configured in siren mode. The siren is working until the signal on input 3 is active (siren can always be activated or disabled by the key B2).</p>
		<p><b>6</b></p> <p>Key B1 is a switch and activates the positive output 1. Key B1 is the Master key by default. <b>Positive input 3</b> is a external activator in <b>pulse mode</b> if the key B2 is configured in siren mode. First pulse on input 3 = siren start, second pulse = siren stop (siren can always be activated or disabled by the key B2).</p>
		<p><b>7</b></p> <p>Key B1 is a switch and activates the positive output 1. Key B1 is the Master key by default. <b>Positive input 3</b> is a external activator in <b>switch mode</b> if the key B2 is configured in siren mode and the key <b>B1 « blue light » is already activated</b>. The siren is working until the signal on input 3 is active (siren can always be activated or disabled by the key B2).</p>
		<p><b>8</b></p> <p>Key B1 is a switch and activates the positive output 1. Key B1 is the Master key by default. <b>Positive input 3</b> is a external activator in <b>pulse mode</b> if the key B2 is configured in siren mode and the key <b>B1 « blue light » is already activated</b>. First pulse on input 3 = siren start, second pulse = siren stop (siren can always be activated or disabled by the key B2).</p>



**11. TiNY8 Operation & Configuration (continued)**





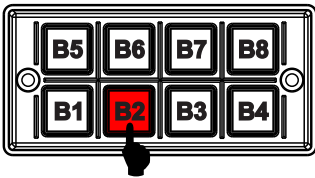

**11.5. Tiny-8 Configuration - MODE 1** 

**10.5.2. Key B2 and negative input 2 configuration**

By default the key B2 is a switch in Slave mode and controls the positive output 2 / negative output 1. It's possible to disable the key B2 and to put a black pictogram on the key to notify the user of the console that the key is not available. When the key is not available then the positive output 2 / negative output 1 are permanent outputs. Some functions of the negative input 2 are also configured by B2 key in configuration mode 1.

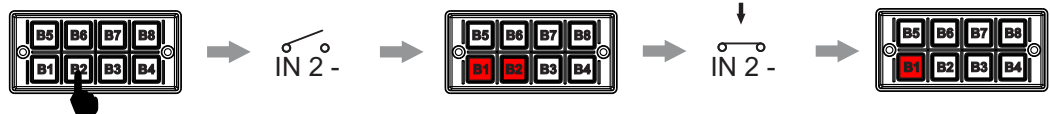

**i** In order to avoid configuration mistakes, it is impossible to configure B2 key in slave mode if the key B1 is disabled. It is also impossible to disable Key B1 if the key B2 is already configured in slave mode.





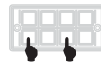

SELECTION	FLASHES	DESCRIPTION
	<b>0</b>	Key B2 is not available and the positive output 2 / negative out 1 are permanent positive outputs.
	<b>1</b>	Key B2 is a switch and activates the positive output 2 / negative output 1. Key B2 is the Slave key by default. Negative input 2 is not used.
	<b>2</b>	Key B2 is a momentary push button and activates the positive output 1 / negative output 2 when it is pressed and positive output 2 / negative output 1 is OFF when key B2 is released. Negative input 2 is not used.
	<b>3</b>	Key B2 is a switch in Slave mode and activates the positive output 2 / negative output 1. Key B2 working is conditioned by the negative input2 (handbrake signal). If the signal is present on negative input 2 the key B2 is disabled and cannot be activated until the signal is still present. Key B2 is not automatically activated if the signal on negative input 2 disappears. 
	<b>4</b>	Key B2 is a switch in Slave mode and activates the positive output 2 / negative output 1. Key B2 working <b>is not</b> conditioned by the negative input2 (handbrake signal).

**11. TiNY8 Operation & Configuration (continued)**

**11.5. Tiny-8 Configuration - MODE 1 (continued)**

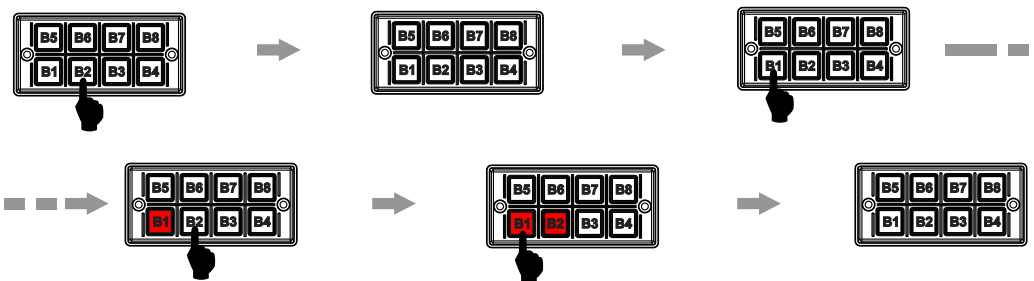

**10.5.2. Key B2 and negative input 2 configuration (continued)**

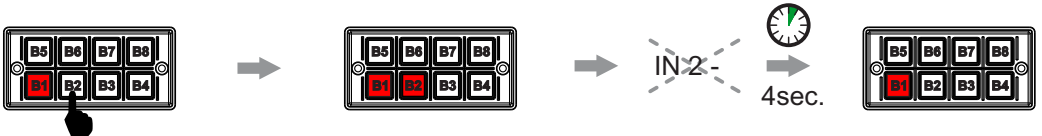
SELECTION	FLASHES	DESCRIPTION
	5	<p>Key B2 is a switch in Salve mode (siren) and controls the positive output 2 / negative output 1.</p> <p>Key 2 is conditioned by the negative input 2 (siren status). When the siren is activated, she send back a negative signal to confirm that all is working perfectly. If this signal disappears then after 4 seconds key B2 is going OFF automatically. Siren can be started again but only by pressing key B2.</p> 
	6	<p>Key B2 is a switch controlling positive output 2 / negative output 1 and is conditioned by the key B1 (Master key, blue light).</p> <p>Key B2 working is conditioned by the negative input2 (handbrake signal). If the signal is present on negative input 2 the key B2 is disabled and cannot be activated until the signal is still present.</p> <p>Key B2 is not automatically activated if the signal on negative input 2 disappears.</p> 
	7	<p>Key B2 is a switch controlling positive output 2 / negative output 1 and is conditioned by the key B1 (Master key, blue light). Key B2 <b>is not</b> conditioned by the negative input 2.</p> 
	8	<p>Key B2 is a switch controlling positive output 2 / negative output 1 and is conditioned by the key B1 (Master key, blue light). Key 2 is also conditioned by the negative input 2 (siren status). When the siren is activated, she send back a negative signal to confirm that all is working perfectly. If this signal disappears then after 4 seconds key B2 is going OFF automatically. Siren can be started again but only by pressing key B2.</p> 

# 11. TiNY8 Operation & Configuration (continued)

## 11.5. Tiny-8 Configuration - MODE 1

### 10.5.3. Key B3 and negative input 2 configuration

By default the key B3 is available and controls the positive output 3. Key B3 is also configured as grill light function. It's possible to disable the key B3 and to put a black pictogram on the key to notify the user of the console that the key is not available. When the key is not available then the positive output 3 is a permanent positive output, going OFF only when console is off or the power supply of the Tiny-8 is disconnected.

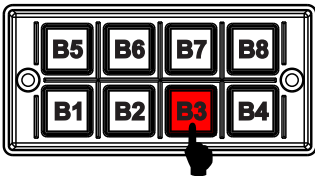

**i** In order to avoid configuration mistakes, it is impossible to configure key B3 in grill light mode if the key B1 is disabled. It is also impossible to disable Key B1 if the key B3 is already configured in grill light mode.

SELECTION	FLASHES	DESCRIPTION
	0	Key B3 is not available and the positive output 3 is permanent positive output.
	1	Key B3 is a switch and activates the positive output 3. No condition.
	2	Key B3 is a momentary push button and activates the positive output 3 when it is pressed and positive output 3 is OFF when key B1 is released.
	3	<p>Key B3 is a switch in « grill light » mode and controls the positive output 3. Key B3 is also activated automatically by key B1 as Master key by default. Key B3 is conditioned by the negative input 2 « handbrake ». If the negative signal is applied on the input 2 « handbrake » then key B3 is going OFF and cannot be activated if the signal on input 2 is still active. Key B3 <b>is not activated again</b> if the negative signal on input 2 disappears.</p>
	4	<p>Key B3 is a switch in « grill light » mode and controls the positive output 3. Key B3 is also activated automatically by key B1 as Master key by default. Key B3 is conditioned by the negative input 2 « handbrake ». If the negative signal is applied on the input 2 « handbrake » then key B3 is going OFF and cannot be activated if the signal on input 2 is still active. Key B3 <b>is activated again</b> if the negative signal on input 2 disappears (if B1 still ON).</p>
5	<p>Key B3 is a switch in « grill light » mode and controls the positive output 3. Key B3 is also activated automatically by key B1 as Master key by default. Key B3 <b>is not</b> conditioned by the negative input 2 « handbrake ».</p>	

# 11. TiNY8 Operation & Configuration (continued)

## 11.5. Tiny-8 Configuration - MODE 1

### 10.5.4. Key B4 and negative input 2 configuration

By default the key B4 is a switch available and is linked to positive output 4 / negative output 2.  
 It's possible to disable the key B4 and to put a black pictogram on the key to notify the user of the console that the key is not available. When the key is not available then the positive output 4 / negative output 2 are permanent outputs, going off only when console is off or the power supply of the Tiny-8 is disconnected.  
 Key B4 can be used as « markup » function.  
 Some functions are linked to the negative input 2.

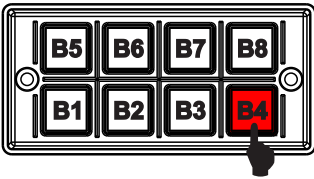

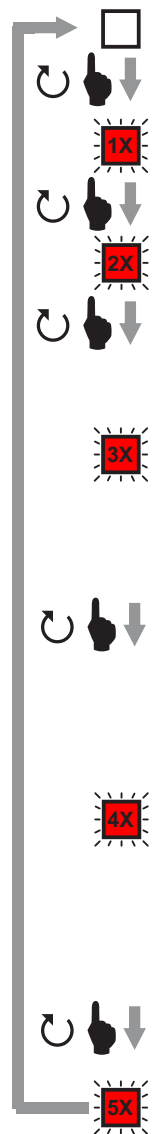
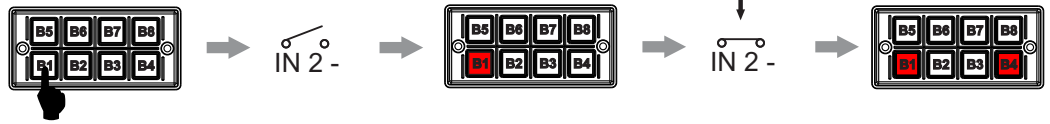
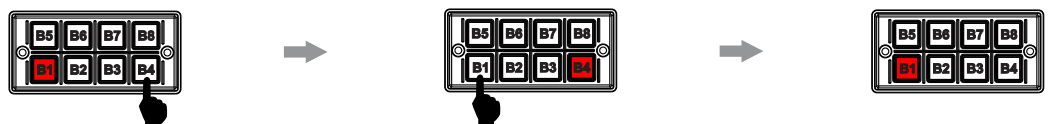
SELECTION	FLASHES	DESCRIPTION
	0	Key B4 is not available and the positive output 4 / negative output 2 are permanent positive outputs.
	1	Key B4 is a switch and activates the positive output 4 / negative output 2. No condition.
	2	Key B4 is a momentary push button and activates the positive output 4 / negative output 2 when it is pressed and the 2 outputs are going OFF when key B4 is released.
	3	Key B4 is a switch working in « markup » mode and controls positive output 4 / negative output 2. Key B4 is activated if key B1 is active (« blue lights ») and « handbrake » signal is applied on negative input 2. Key B4 can be controlled manually when key B1 is active and « handbrake » is ON. 
	4	Key B4 is an exclusive switch working in « markup » mode and controls positive output 4 / negative output 2. Key B1 and key B4 are in « group » mode : if key B1 is active and key B4 is pressed then key B1 is going OFF automatically. If key B4 is active and key B1 is pressed then key B4 is going OFF automatically. No interlock function with negative input 2. 
5	Key B4 is a switch and activates the positive output 4 / negative output 2. Key B4 is included inside the scene 2, only if key B6 is configured in scene 2 mode. See key B6 configuration in scene 2 mode on page 22.	

# 11. TiNY8 Operation & Configuration (continued)

## 11.5. Tiny-8 Configuration - MODE 1

### 10.5.5. Key B5 configuration





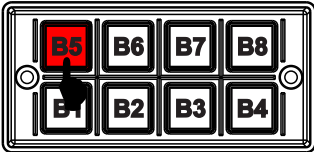

By default the key 5 is a switch available and is linked to positive output 5.

It's possible to disable the key B5 and to put a black pictogram on the key to notify the user of the console that the key is not available. When the key is not available then the positive output 5 is permanent output, going off only when console is off or the power supply of the Tiny-8 is disconnected.

Key B5 can be used as scene activator or arrowstick controller with or without handbrake condition.

Some functions are linked to the negative input 2.



SELECTION	FLASHES	DESCRIPTION
	<b>0</b>	Key B5 is not available and the positive output 5 is permanent positive output.
	<b>1</b>	Key B5 is a switch and activates the positive output 5. No condition.
	<b>2</b>	Key B5 is a momentary push button and activates the positive output 5 when it is pressed and the positive output 5 is going OFF when key B5 is released.
	<b>3</b>	Key B5 is a switch and is included in the group 1 with B6, B7 and B8 if they are configured in group 1 mode. See the description of the function group 1 on page 25. Special conditions with negative input 2 for group 1 are available in configuration mode 2 (see page 28).
	<b>4</b>	Key B5 is a switch and is included in the group 2 with B6, B7 and B8 if they are configured in group 2 mode. See the description of the function group 2 on page 25. Special conditions with negative input 2 for group 2 are available in configuration mode 2 (see page 28).
	<b>5</b>	Key B5 is a switch and starts the scene 1. Scene 1 starts automatically the keys B1, B2, B3 and B4. If B6 is configured in scene 2 mode, so B5 and B6 are working like a group (only one key ON at the same time). See page 26 for more details.







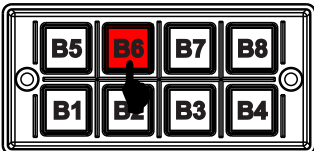

# 11. TiNY8 Operation & Configuration (continued)

## 11.5. Tiny-8 Configuration - MODE 1

### 10.5.6. Key B6 configuration

By default the key 6 is a switch available and is linked to positive output 6.  
 It's possible to disable the key B6 and to put a black pictogram on the key to notify the user of the console that the key is not available. When the key is not available then the positive output 6 is permanent output, going off only when console is off or the power supply of the Tiny-8 is disconnected.  
 Key B6 can be used as scene activator or arrowstick controller with or without handbrake condition.  
 Some functions are linked to the negative input 2.

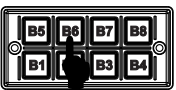
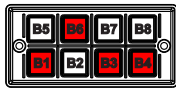
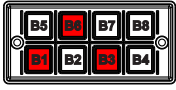

SELECTION	FLASHES	DESCRIPTION
	0	Key B6 is not available and the positive output 6 is permanent positive output.
	1	Key B6 is a switch and activates the positive output 6. No condition.
	2	Key B6 is a momentary push button and activates the positive output 6 when it is pressed and the positive output 6 is going OFF when key B6 is released.
	3	Key B6 is a switch and is included in the group 1 with B5, B7 and B8 if they are configured in group 1 mode. See the description of the function group 1 on page 25. Special conditions with negative input 2 for group 1 are available in configuration mode 2 (see page 28).
	4	Key B6 is a switch and is included in the group 2 with B5, B7 and B8 if they are configured in group 2 mode. See the description of the function group 2 on page 25. Special conditions with negative input 2 for group 2 are available in configuration mode 2 (see page 28).
	5	<p>Key B6 is a switch and starts the scene 2.                      Scene 2 starts automatically the keys B1, B3, and B4 if key B4 is included in the scene 2 (see configuration page 20, last option).                      If B5 is configured in scene 1 mode, so B5 and B6 are working like a group (only one key ON at the same time). See page 26 for more details.</p> <div style="display: flex; align-items: center; justify-content: center;">  <span style="margin: 0 20px;">→</span>  <div style="margin-left: 20px;">If B4 included in scene 2.</div> </div> <p style="text-align: center; margin: 10px 0;"><b>OR</b></p> <div style="display: flex; align-items: center; justify-content: center;">  <div style="margin-left: 20px;">If B4 not included in scene 2.</div> </div>

# 11. TiNY8 Operation & Configuration (continued)

## 11.5. Tiny-8 Configuration - MODE 1

### 10.5.7. Key B7 configuration





By default the key 7 is a switch available and is linked to positive output 7.

It's possible to disable the key B7 and to put a black pictogram on the key to notify the user of the console that the key is not available. When the key is not available then the positive output 7 is permanent output, going off only when console is off or the power supply of the Tiny-8 is disconnected.

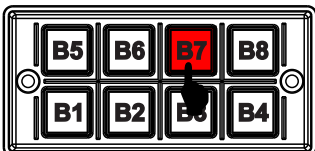
Key B7 can be used as arrowstick controller with or without handbrake condition.

Some functions are linked to the negative input 2.



SELECTION	FLASHES	DESCRIPTION
	0	Key B7 is not available and the positive output 7 is permanent positive output.
	1	Key B7 is a switch and activates the positive output 7. No condition.
	2	Key B7 is a momentary push button and activates the positive output 7 when it is pressed and the positive output 7 is going OFF when key B7 is released.
	3	Key B7 is a switch and is included in the group 1 with B5, B6 and B8 if they are configured in group 1 mode. See the description of the function group 1 on page 25. Special conditions with negative input 2 for group 1 are available in configuration mode 2 (see page 28).
	4	Key B7 is a switch and is included in the group 2 with B5, B6 and B8 if they are configured in group 2 mode. See the description of the function group 2 on page 25. Special conditions with negative input 2 for group 2 are available in configuration mode 2 (see page 28).

# 11. TiNY8

## Operation & Configuration (continued)

### 11.5. Tiny-8 Configuration - MODE 1

#### 10.5.8. Key B8 configuration





By default the key 8 is a switch available and is linked to positive output 8.

It's possible to disable the key B8 and to put a black pictogram on the key to notify the user of the console that the key is not available. When the key is not available then the positive output 8 is permanent output, going off only when console is off or the power supply of the Tiny-8 is disconnected.

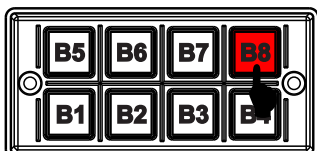
Key B7 can be used as arrowstick controller with or without handbrake condition.

Some functions are linked to the negative input 2.



SELECTION	FLASHES	DESCRIPTION
	0	Key B8 is not available and the positive output 8 is permanent positive output.
	1	Key B8 is a switch and activates the positive output 8. No condition.
	2	Key B8 is a momentary push button and activates the positive output 8 when it is pressed and the positive output 8 is going OFF when key B8 is released.
	3	Key B8 is a switch and is included in the group 1 with B5, B6 and B7 if they are configured in group 1 mode. See the description of the function group 1 on page 25. Special conditions with negative input 2 for group 1 are available in configuration mode 2 (see page 28).
	4	Key B8 is a switch and is included in the group 2 with B5, B6 and B7 if they are configured in group 2 mode. See the description of the function group 2 on page 25. Special conditions with negative input 2 for group 2 are available in configuration mode 2 (see page 28).



# 11. TiNY8 Operation & Configuration (continued)

## 11.5. Tiny-8 Configuration - MODE 1 (continued)

### 11.5.9. Description of group 1 for keys B5-B6-B7-B8

If the keys B5, B6, B7 and B8 are configured in the group 1 mode, only one of these 4 keys can be activated at the same time.

Key B5 controls the positive output 5.

Key B6 controls the positive output 6.

Key B7 controls the positive outputs 6 and 8.

Key B8 controls the positive output 8.

The positive output 7 is a permanent positive output.

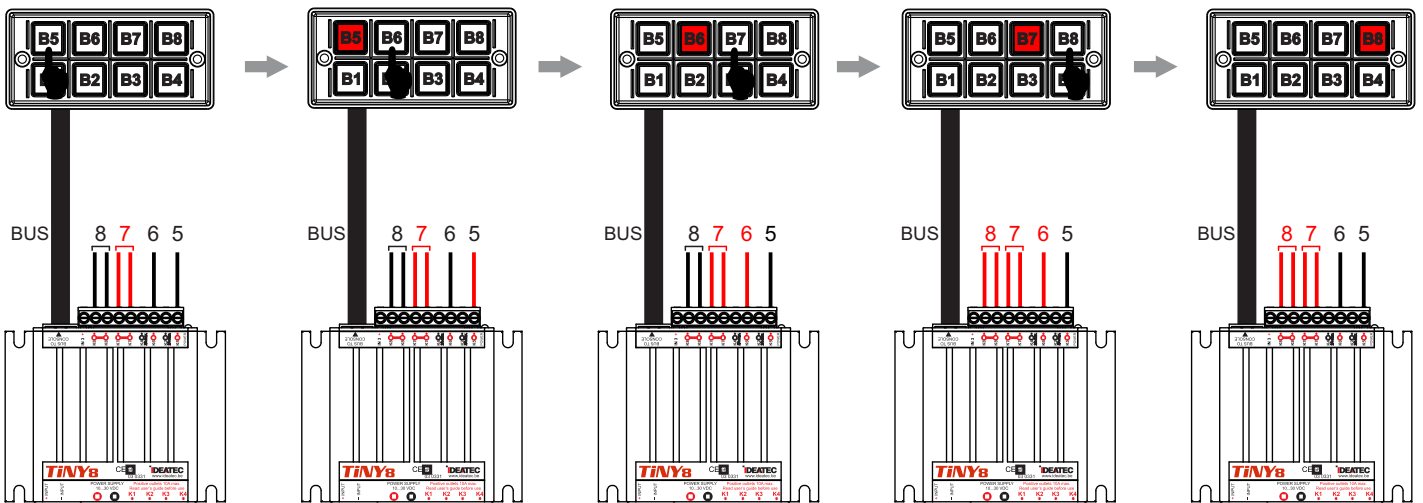

### 11.5.10. Description of group 2 for keys B5-B6-B7-B8

If the keys B5, B6, B7 and B8 are configured in the group 2 mode, only one of these 4 keys can be activated at the same time.

Key B5 controls the positive output 5.

Key B6 controls the positive output 6.

Key B7 controls the positive output 7.

Key B8 controls the positive output 8.

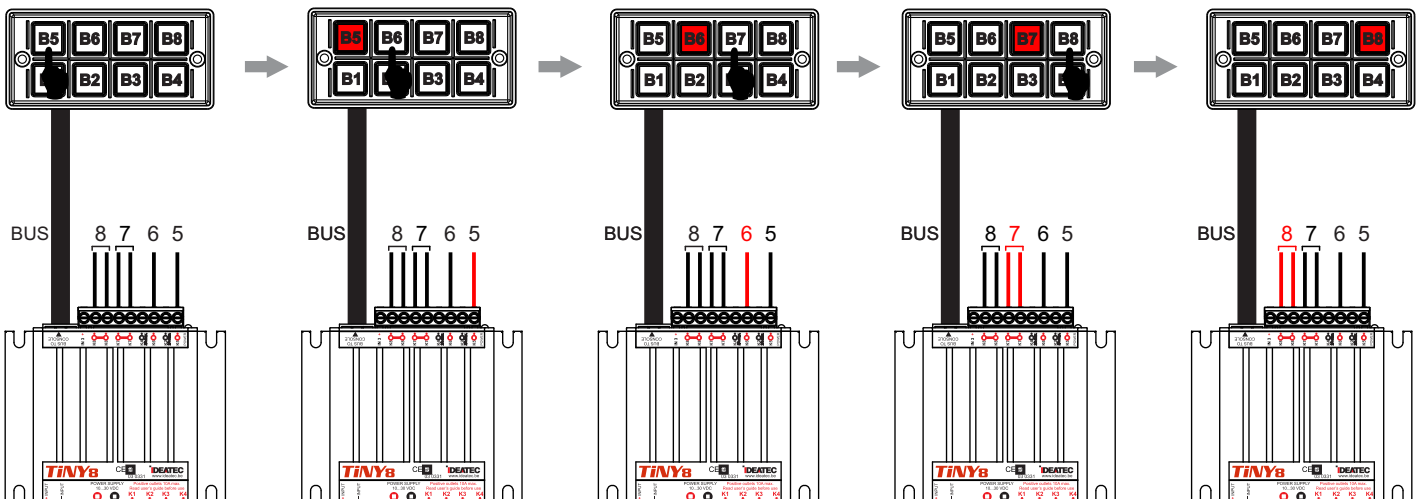

## 11. TiNY8

## Operation & Configuration (continued)

### 11.5. Tiny-8 Configuration - MODE 1

#### 11.5.11. Description of the scenes 1 and 2 controlled by B5 and B6 keys

Keys B5 and B6 can be configured like scene 1 and scene 2 activators (see page 21 and 22). Scene 1 and 2 are exclusive, they cannot, by definition, be activated at the same time. B5 starts the keys B1, B2, B3 and B4 whereas B6 starts the keys B1, B3 and B4 (B4 in option).

If B4 not included in the scene 2.

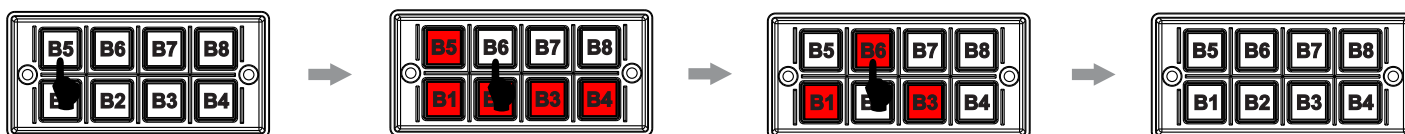

If B4 included in the scene 2.

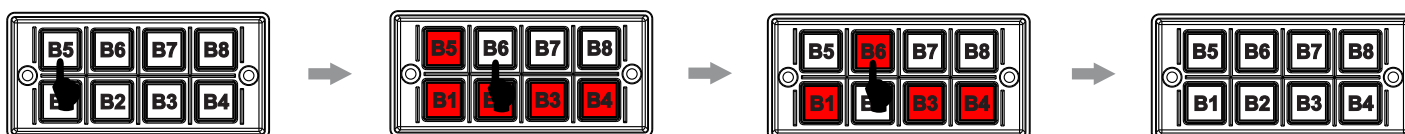

**i** — Some options for keys B1, B2, B3 and B4 are not compatible with scenes configured on B5 and B6 ( example : momentary push button for the key B1).

## 11. TiNY8 Operation & Configuration (continued)

### 11.6. Tiny-8 Configuration - MODE 2

#### 11.6.1. Automatic standby configuration for Tiny-8

Configuration on key B1.

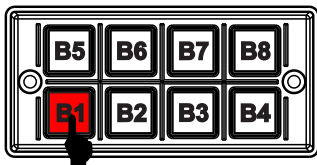

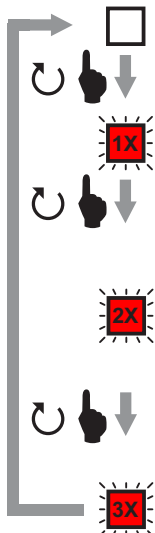
SELECTION	FLASHES	DESCRIPTION
	0	Automatic standby after <b>1</b> minute if no keys are activated and positive signal from +ignition is not present on positive input 1 of the Tiny-8.
	1	Automatic standby after <b>15</b> minutes if no keys are activated and positive signal from +ignition is not present on positive input 1 of the Tiny-8.
	2	Automatic standby after <b>1</b> minute if no keys are activated and positive signal from +ignition is not present on positive input 1 of the Tiny-8. If long press on key B4 then all the keys are going OFF (permanent outputs stay ON) and the system is falling into sleep after 20 seconds (permanent outputs are going OFF).
	3	Automatic standby after <b>15</b> minutes if no keys are activated and positive signal from +ignition is not present on positive input 1 of the Tiny-8. If long press on key B4 then all the keys are going OFF (permanent outputs stay ON) and the system is falling into sleep after 20 seconds (permanent outputs are going OFF).

#### 11.6.2. Configuration of the flashes on B4 when Tiny-8 is in standby mode.

Configuration on key B2.

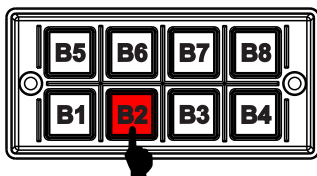

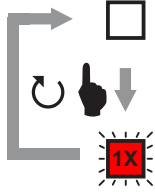
SELECTION	FLASHES	DESCRIPTION
	0	Key B4 is flashing when Tiny-8 is in standby mode.
	1	Key B4 is <b>not</b> flashing when Tiny-8 is in standby mode.

# 11. TiNY8 Operation & Configuration (continued)

## 11.6. Tiny-8 Configuration - MODE 2 (continued)



### 11.6.3. Conditions for arrowstick lightbar configuration

The configuration is made by the key B5 and gives the possibility to configure conditions with negative input 2 (« handbrake ») for the keys B5, B6, B7 and B8 if they are configured in group 1 or group 2 mode.

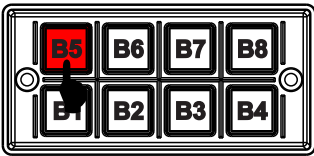

SELECTION	FLASHES	DESCRIPTION
	0	No condition for the keys B5, B6, B7 and B8.
	1	<p>Keys B5, B6, B7 and B8 are conditioned by negative input 2 (« handbrake ») if they are configured in group 1 or group 2 mode.</p> <p> </p> <p> </p>
	2	<p>Keys B5, B6, B7 and B8 are conditioned by negative input 2 (« handbrake ») if they are configured in group 1 or group 2 mode and the negative input 2 starts automatically the key B5 (« Warning mode »).</p> <p> </p>
	3	<p>Keys B5, B6, B7 and B8 are conditioned by negative input 2 (« handbrake ») if they are configured in group 1 or group 2 mode and the negative input 2 combined with key B1 activated (« blue lights ») starts automatically the key B5 (« Warning mode »).</p> <p> </p>

## 12. TINY8

## All our user guides on one CD-ROM

A CD-ROM with all operating modes is provided with each IDEATEC product



PDF format for easy access,  
guaranteed updates,  
ecologic.

## 13. TINY8

## Your warranty

IDEATEC S.A hereby guarantees that this product is free from defects in material and workmanship for a period of two years from the date of purchase. If, during the warranty period, the product fails due to material or workmanship defects, IDEATEC S.A. will repair or replace (at IDEATEC S.A.'s discretion) the product free of charge, under the following conditions: IDEATEC S.A. reserves the right (at its own discretion) to replace parts of defective products or replace the products low value with new or factory refurbished parts or products. Conditions:

1. This warranty is valid only if the device is accompanied by the original invoice or receipt (containing the date of purchase, the type of product, and the name of the reseller). IDEATEC S.A. reserves the right to deny its free warranty if the aforementioned documents cannot be produced or if the information contained in them are incomplete or illegible.
2. This warranty does not reimburse or cover deterioration resulting from adaptations or adjustments to the product without prior written consent from IDEATEC S.A., mainly to respect technical or safety standards, national or local, in effect in all countries other than for those for which the product is known and manufactured.
3. This warranty does not apply if the model or serial number on the product has been altered, erased, suppressed, or illegible.
4. This warranty does not cover any of the following points:
  - a. Periodic maintenance and repair or replacement of parts from normal usage;
  - b. Any adaptations or modifications aimed at improving the product such as it has been purchased and described in the operating instructions, without prior written agreement from IDEATEC S.A.;
  - c. Transportation costs, home delivery costs, and all transport risks directly or indirectly associated with this product's warranty;
  - d. Installation, removal, and reinstallation costs;
  - e. Deterioration resulting from:
    1. Misuse, including, without limitation, (a) improper use of the product without respecting IDEATEC S.A.'s instructions on proper product usage and maintenance, and (b) installation or usage of the product against IDEATEC S.A.'s instructions or technical or safety standards in effect in the country where it is used, and (c) improper or incorrect software installation;
    2. Repairs performed by unauthorised repair persons or by the user;
    3. Accidents, lightning, flood, fire, improper ventilation, or any other case that exceeds IDEATEC S.A. liability;
    4. Failure of the system on which the product is installed.
5. This warranty does not limit the client's statutory rights under national laws in effect in any way, nor the client's rights before the reseller, stipulated in the sales/purchasing contract.

## TABLE OF CONTENTS

Chapter 1 : Safety and precautions.....	2
Chapter 2 : Dimensioning of electric wires.....	2
Chapter 3 : Product description.....	3
3.1. Description.....	3
3.2. View of assembly.....	3
Chapter 4 : Elements identification.....	3
4.1. Console.....	3
4.2. Bus cable 2xRJ45 - Console < > Module.....	4
4.3. Power module.....	4
4.4. Pictogram collection.....	4
Chapter 5 : Console and Module installation.....	5
5.1. Console.....	5
5.2. Power module.....	6
Chapter 6 : Drilling Templates .....	7
6.1. Controlling the template scale after printing.....	7
6.2. Console mounting foot.....	7
6.3. TINY-8 Power module.....	8
Chapter 7 : Technical characteristics.....	9
7.1. Console.....	9
7.2. Power module.....	9
Chapter 8 : Wiring diagram.....	9
Chapter 9 : Connecting.....	10
9.1. Connectors and wiring terminals supplied .....	10
9.2. TINY-8 power module.....	10
Chapitre 10 : Configuration by default.....	11

## TABLE OF CONTENTS (CONTINUED)

Chapter 11 : Operation & Configuration.....	12
11.1. TINY-8 console.....	12
11.2. Description of the different light and sound codes.....	12
11.3. Keys operation.....	12
11.3.1. No backlighting is present and key B4 is lit briefly every 5 seconds.....	12
11.3.2. The key B1, B2, B3, ... or B8 is permanently lit.....	12
11.4. Before to configure the TINY-8.....	13
11.4.1. Selection and placement of pictograms on the keys.....	13
11.4.2. Conditions for configuration.....	13
11.4.3. To enter in configuration mode and to save your configuration.....	13
11.4.4. To save your configuration.....	14
11.5. TINY-8 Configuration - Mode 1.....	15
11.5.1. Key B1 and positive input 3 configuration.....	15
11.5.2. Key B2 and negative input 2 configuration.....	17
11.5.3. Key B3 and negative input 2 configuration.....	19
11.5.4. Key B4 and negative input 2 configuration.....	20
11.5.5. Key B5 configuration.....	21
11.5.6. Key B6 configuration.....	22
11.5.7. Key B7 configuration .....	23
11.5.8. Key B8 configuration.....	24
11.5.9. Description of <u>group 1</u> for keys B5-B6-B7-B8 .....	25
11.5.10. Description of <u>group 2</u> for keys B5-B6-B7-B8 .....	25
11.5.11. Description of the scenes 1 and 2 controlled by B5 and B6 keys .....	26
11.6. TINY-8 Configuration - Mode 2.....	27
11.6.1. Automatic standby configuration for TINY-8.....	27
11.6.2. Configuration of the flashes on B4 when TINY-8 is in standby mode.....	27
11.6.3. Conditions for arrowstick lightbar configuration.....	28
 Chapter 12 : All our user guides on one CD-ROM.....	 29
 Chapter 13 : Your warranty.....	 29